

X-STEP	A0	RX	D1
X-DIR	A1	TX	D2
Y-EN	A2	D2	X-MAX
A3	A3	D3	X-MIN
A4	A4	D4	D4
A5	A5	D5	D5
Y-STEP	A6	D6	D6
Y-DIR	A7	D7	D7
Z-EN	A8	D8	D8
A9	A9	D9	D9
A10	A10	D10	D10
A11	A11	D11	D11
A12	A12	D12	D12
THERM0	A13	D13	LED
THERM1	A14	D14	Y-MIN
THERM2	A15	D15	Y-MAX
RESET	RES	D16	D16
AM-VIN	VIN	D17	D17
VCC	5V	D18	Z-MIN
AREF	3.3V	D19	Z-MAX
GND	GND	D20	SDA
GND	GND	D21	SCL
GND	GND	D22	D22
GND	GND	D23	D23
GND	GND@2	D24	EO-EN
GND	GND@4	D25	D25
VCC	5V@1	D26	EO-STEP
VCC	5V@2	D27	D27
D41	D41	D28	EO-DIR
D42	D42	D29	D29
D43	D43	D30	E1-EN
D44	D44	D31	D31
D45	D45	D32	D32
Z-STEP	D46	D33	D33
D47	D47	D34	E1-DIR
Z-DIR	D48	D35	D35
D49	D49	D36	E1-STEP
MISO	D50	D37	D37
MOSI	D51	D38	X-EN
SCK	D52	D39	D39
D53	D53	D40	D40

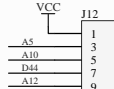
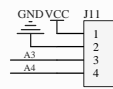
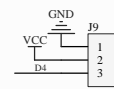
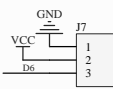
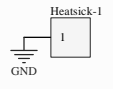
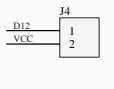
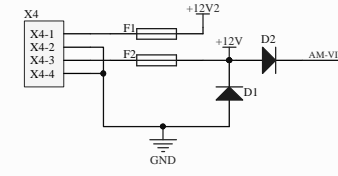
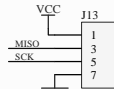
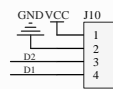
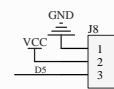
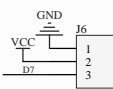
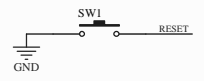
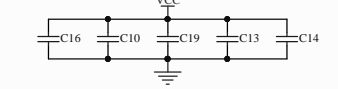
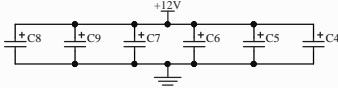
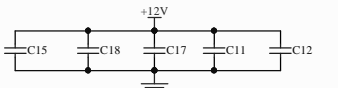
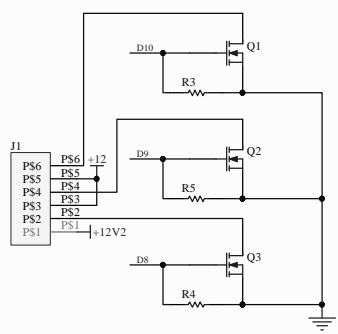
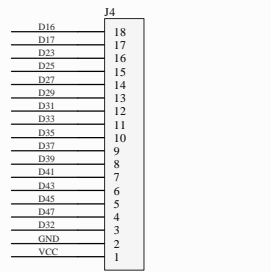
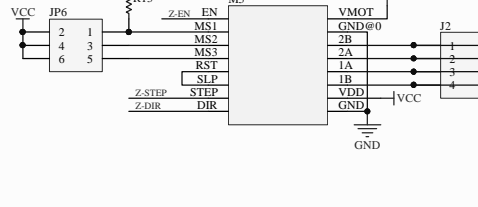
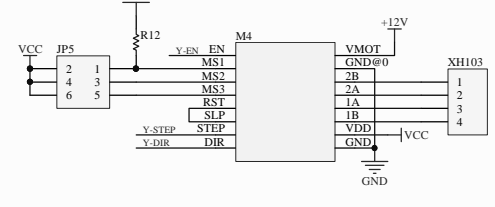
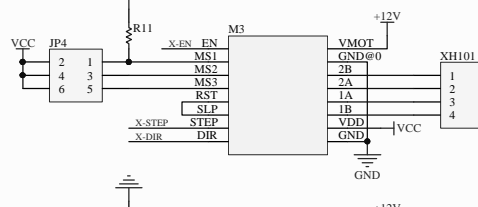
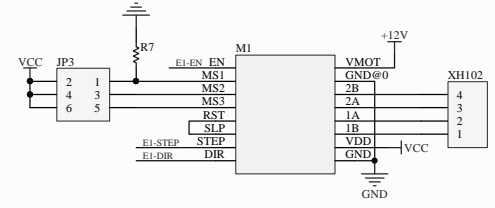
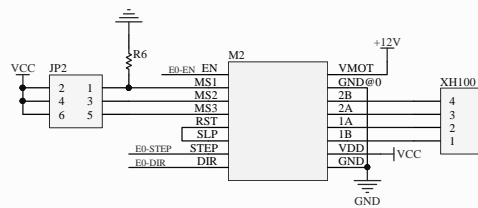
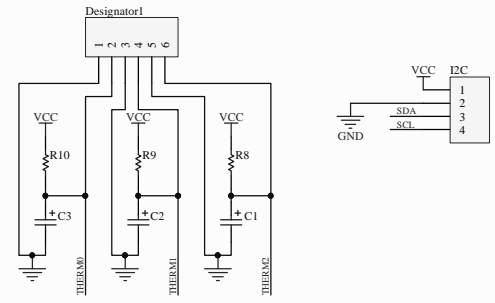
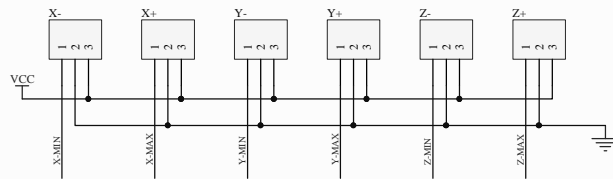
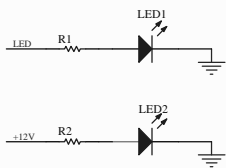

**RobotDyn**  
www.robotdyn.com

**RAMPS 1.4 Shield**